

Spool valve

Flange construction

- ◆ pilot operated
- ◆ 4/2-way impulse execution detented
- ◆ 4/3-way with spring centred mid position
- ◆ 4/2-way with spring reset
- ◆ $Q_{max} = 160 \text{ l/min}$
- ◆ $p_{max} = 350 \text{ bar}$

NG10
ISO 4401-05

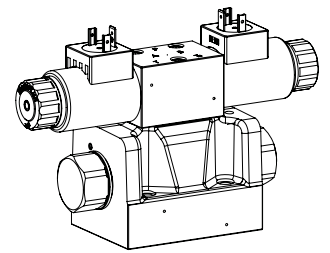

DESCRIPTION

Pilot operated 4-way valve in a 5 chamber system. The control of the pilot valve takes place electrically. Very compact construction with corresponding low weight and high flow values. The hydraulic control of the pilot valve can be internal or external via an additional connection plate or the mounting interface depending on the type of pilot operation. Spool detented or with spring reset. Precise spool fit, low leakage, long service life time. Spool made from hardened steel, valve body from high quality hydraulic cast steel.

APPLICATION

Spool valves are mainly used for controlling direction of movement and stopping of hydraulic cylinders and motors. Pilot operated valves are used where large volume flows have to be controlled. Switching performance and leakage of the valves must be taken into account when designing the system. Solenoid spool valves are suitable for machine tools and handling systems of any kind.

SYMBOL

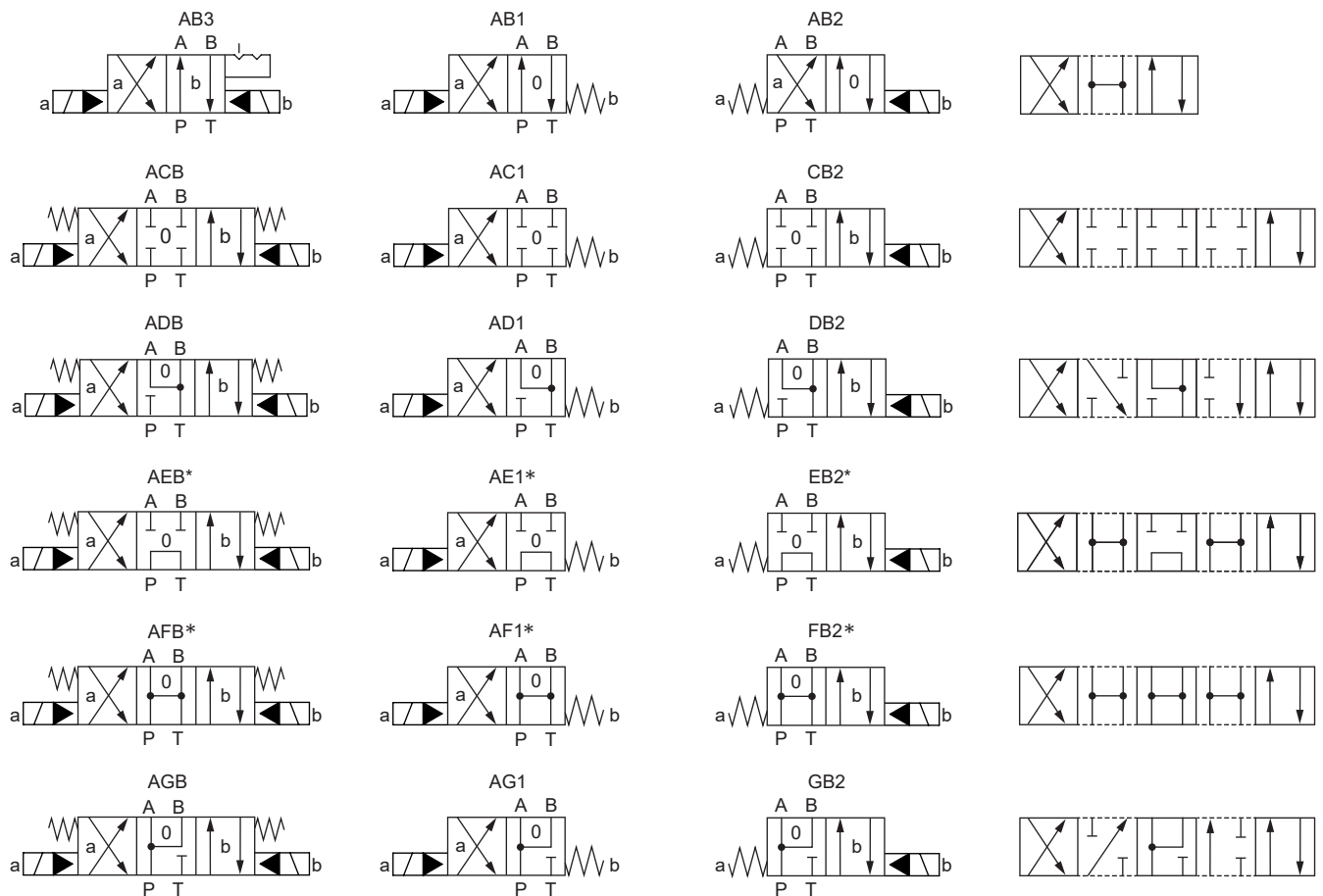

* When the connections P and T are connected in the middle position, a back pressure cartridge is built in as standard in the case of internal pilot oil supply (ti/pi). If this back pressure valve is not used (0, according to the type code), it must be ensured that a pilot pressure of minimum 4 bar is present. The pressure difference of this cartridge has to be added to the pressure difference of the main valve (see characteristics) which results in an overall value. Pilot control type xi is not available with a back pressure cartridge.

Types of pilot operation

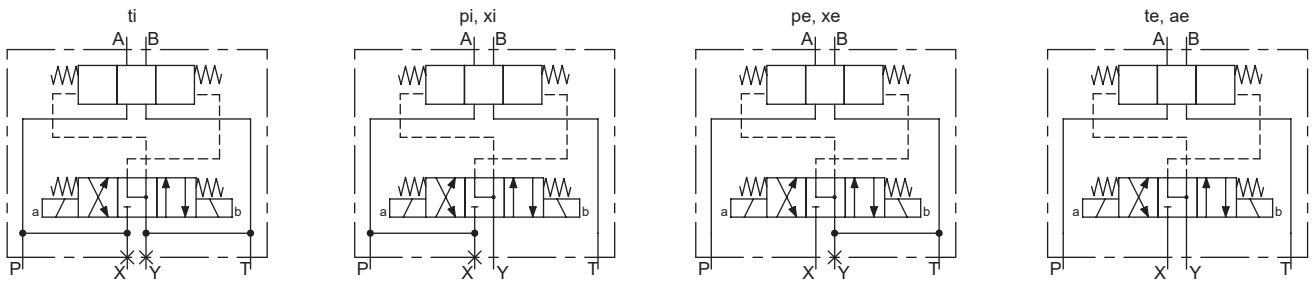

TYPE CODE

WVM F A10 - - - - / - #

Spool valve pilot operated, solenoid operated

Flange construction

International standard interface ISO NG10

Designation of symbols acc. to table

Back pressure cartridge Standard only symbols AEB and AFB without back pressure cartridge see notes Section symbols

Type of pilot operation:
 Pilot oil supply (x) and drain (y) (x) and (y) internally via control plate: ti (x) and (y) externally te (x) internally (y) externally pi (x) externally (y) internally via mounting interface: ae (x) internally (y) externally xi (x) externally (y) internally xe

Nominal voltage U_N 12 VDC G12 115 VDC R115 24 VDC G24 230 VAC R230 without coil X5

Slip-on coil Metal housing square with one-sided collar N Metal housing round with one-sided collar V (only G12 and G24)

Connection execution Connector socket EN 175301-803/ISO 4400 D Connector socket AMP Junior-Timer J (only for $U_N \leq 75$ VDC) Connector Deutsch DT04-2P G (only for $U_N \leq 75$ VDC)

Sealing material NBR D1 FKM (Viton)

Manual override pilot valve Integrated Push-button HF1 Actuation pressures see pilot valve Spindle HS1 Actuation pressures see pilot valve

Dampening orifices in control connections A and B without orifice orifice $\varnothing 0,5$ mm Q 0,5 Provide for control pressure above 100 bar

Design index (subject to change)

GENERAL SPECIFICATIONS

Designation	4/2-, 4/3-spool valve
Mounting	Flange construction
Nominal size	NG10 according to ISO 4401-05
Actuation	Electrical
Ambient temperature	-25...+70 °C if > +50 °C, then no undervoltage is admissible
Weight	3,5 kg (1 solenoid) 3,8 kg (2 solenoids) 0,3 kg control plate
MTTFd	150 years

HYDRAULIC SPECIFICATIONS

Working pressure	$p_{max} = 350$ bar
Tank pressure	$p_{Tmax} = 160$ bar (type of pilot operation te, pi, ae and xi) $p_{Tmax} = 100$ bar (type of pilot operation ti, pe and xe)
Pilot pressure	p_{vmin} : 8...14 bar, see performance limits $p_{vmax} = 350$ bar for connection X (control plate) $p_{vmax} = 200$ bar for connection X (mounting interface)
Pressure pilot oil drain	minimum lower by p_{vmin}
Maximum volume flow	$Q_{max} = 160$ l/min
Leakage oil	See characteristic and pilot valves
Fluid	Mineral oil, other fluid on request
Viscosity range	12 mm ² /s...320 mm ² /s
Temperature range fluid	-20...+70 °C (NBR) -20...+70 °C (FKM)
Contamination efficiency	Class 20 / 18 / 14
Filtration	Required filtration grade $\beta_{10...16} \geq 75$, see data sheet 1.0-50

SURFACE TREATMENT

- ◆ The main valve body, the distance plate, the screw plugs, the slip-on coil and the armature tube are zinc-nickel coated
- ◆ The pilot valve body is coated with a two component paint

ACTUATION

Solenoid spool valve direct operated
 Data sheet 1.2-33 (slip-on coil)
 WDMFA04-AB1 / AB2 for 4/2-way AB1 / AB2
 WDMFA04-AD1 / DB2 for other 4/2-way
 WDMFA04-ADB for 4/3-way with spring centred mid position
 WDMFA04-ADB for 4/2-way impulse execution detented

INSTALLATION NOTES

Mounting type	Flange mounting 4 fixing holes for socket head screws M6 x 40
Mounting position	Any, preferably horizontal
Tightening torque	$M_D = 13.5$ Nm \pm 10 %, quality min. 10.9 $M_D = 10.5$ Nm \pm 10 %, quality 8.8: ◆ maximum tank pressure without external connections: 80 bar ◆ maximum tank pressure and maximum pressure external connections: 35 bar

Note!



The length of the fixing screw depends on the base material of the connection element.

SEALING MATERIAL

NBR or FKM (Viton) as standard, choice in the type code

PERFORMANCE SPECIFICATIONS

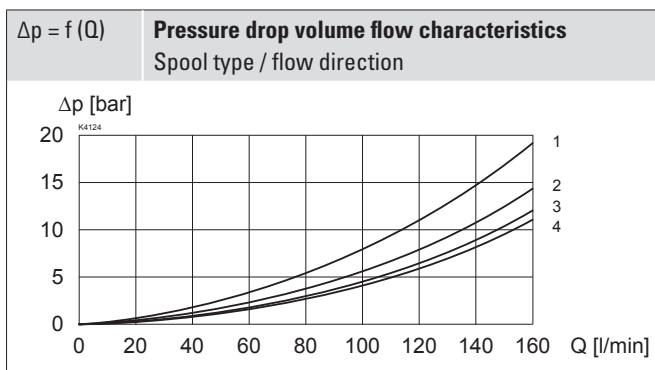
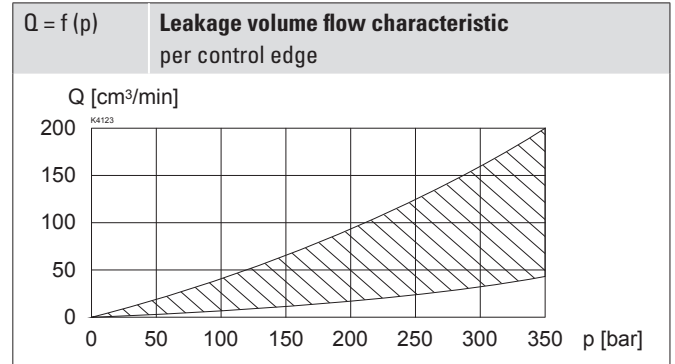
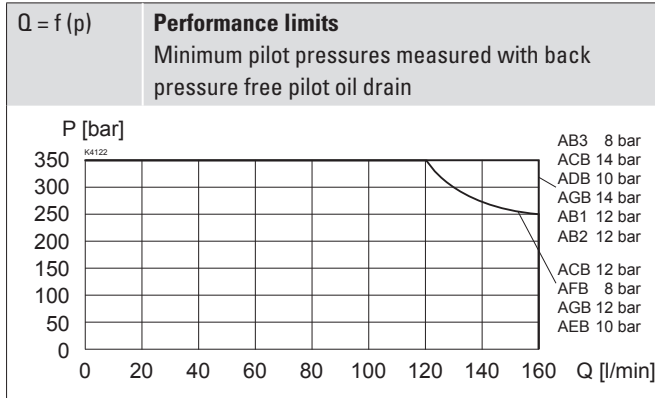
 Oil viscosity $\nu = 30 \text{ mm}^2/\text{s}$

Symbol	Volume flow direction				
	P - A	P - B	P - T	A - T	B - T
AB.	3	3	-	2	1
ACB	3	3	-	2	1
ADB	3	3	-	2	1
AEB	3	3	1	2	1
AFB	2	2	4	4	2
AGB	2	2	-	2	1

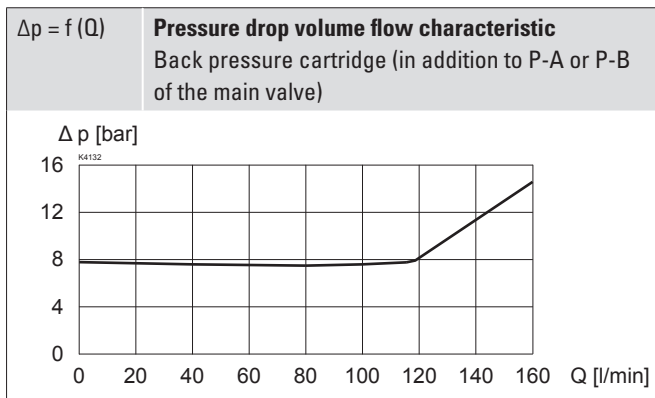
Note!

*Please ensure the minimum pilot pressure. Attention internal pilot connections: valves only switch when the pressure difference in the valve is high enough. Further details on request.

HYDRAULIC CONNECTION

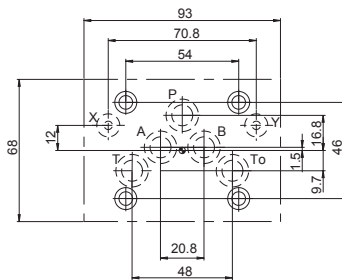

ACCESSORIES

Fixing screws	Data sheet 1.0-60
Threaded subplates	Data sheet 2.9-40
Multi-station subplates	Data sheet 2.9-70
Horizontal mounting blocks	Data sheet 2.9-110
Technical explanations	Data sheet 1.0-100
Filtration	Data sheet 1.0-50

PARTS LIST

Position	Article	Description
20	246.2141	Socket head screw M5 x 40 DIN 912
	246.2160	Socket head screw M5 x 60 DIN 912
70	238.1405	Screw plug VSTI G1/8"-ED
90	173.1500	Control plate NG4 Mini
	251.2923	Seal kit WV.FA10
Seal kit consisting of		
30	O-ring	ID 12,42 x 1,78
40	O-ring	ID 7,65 x 1,78
60	O-ring	ID 5,28 x 1,78

STANDARDS

Mounting interface	ISO 4401-05
Solenoids	DIN VDE 0580
Connection execution D	EN 175301 – 803
Protection class	EN 60 529
Contamination efficiency	ISO 4406