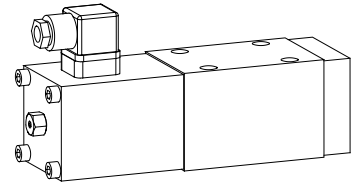

**Solenoid operated spool valve**

- 4/2-way impulse valve
- 4/3-way with spring centred mid position
- 4/2-way with spring reset
- $Q_{\max} = 100 \text{ l/min}$ ,  $p_{\max} = 350 \text{ bar}$

**NG10**  
 ISO 4401-05

**DESCRIPTION**

Direct operated solenoid valve with 4 ports in 5 chamber design. Spool detented or with spring reset. Precise spool fit, low leakage, long life time. Threaded ports through additional base plate. Spool made from hardened steel, body from high quality cast steel. Wide range of standard and special voltages. The body made of high grade hydraulic casting for long service life is painted. The solenoid and the cover are zinc coated. The socket head screws are zinc coated.

**FUNCTION**

- 4/2-way detented spool valve: 2 solenoids and 2 detented positions. With the solenoids deenergised the spool remains in the last switched position.
- 4/2-way spool valve: 1 solenoid and 2 spool positions, spring off-set. With the solenoid deenergised the spool returns to the offset position.
- 4/3-way spool valve: 2 solenoids and 3 spool positions, spring centered. With the solenoids deenergised the spool returns to the center position.

**APPLICATION**

Solenoid operated spool valves are mainly used for controlling direction of movement and stopping of hydraulic cylinders and motors. Direction of movement depends on the position of spool and its flow symbol. Please pay attention to the performance limits and leakage of the valves. Solenoid operated spool valves are suitable for machine tools and handling systems.

**TYPE CODE**

International standard interface ISO	A	<input type="checkbox"/>	4	<input type="checkbox"/>	-	<input type="checkbox"/>	#	<input type="checkbox"/>
Medium-solenoid	<input type="checkbox"/>	<input type="checkbox"/>	<input type="checkbox"/>	<input type="checkbox"/>	<input type="checkbox"/>	<input type="checkbox"/>	<input type="checkbox"/>	<input type="checkbox"/>
Super-solenoid	<input type="checkbox"/>	<input type="checkbox"/>	<input type="checkbox"/>	<input type="checkbox"/>	<input type="checkbox"/>	<input type="checkbox"/>	<input type="checkbox"/>	<input type="checkbox"/>
Number of control ports								
Description of symbol refer to table								
Nominal voltage $U_N$	12 VDC	<input type="checkbox"/>	G12					
	24 VDC	<input type="checkbox"/>	G24					
	110 VAC	<input type="checkbox"/>	R110					
	115 VAC	<input type="checkbox"/>	R115					
	230 VAC	<input type="checkbox"/>	R230					
Design-Index (Subject to change)								

**GENERAL SPECIFICATIONS**

Description	4/2-, 4/3-way spool valve
Nominal size	NG10 to ISO 4401-05
Construction	Direct operated spool valve
Operating method	Solenoid
Mounting	Flange 4 fixing holes for socket head screws M6x65
Connections	Threaded connection plates Multi-flange subplates Longitudinal stacking system
Ambient temperature	-20...+50 °C
Mounting position	any, preferably horizontal
Fastening torque	$M_E = 9,5 \text{ Nm}$ (screw quality 8.8)
Weight: 4/2-way impuls	$m = 6,0 \text{ kg}$
4/3-way	$m = 6,0 \text{ kg}$
4/2-way (1 solenoid)	$m = 4,5 \text{ kg}$

**HYDRAULIC SPECIFICATIONS**

Fluid	Mineral oil, other fluid on request
Contamination efficiency	ISO 4406:1999, classe 20/18/14 (Required filtration grade $\beta_{10...16} \geq 75$ ) refer to data sheet 1.0-50/2
Viscosity range	12 mm <sup>2</sup> /s...320 mm <sup>2</sup> /s
Fluid temperature	-20...+70 °C
Operating pressure in port P, A, B	$p_{\max} = 350 \text{ bar}$
Tank pressure in port T	Medium: $p_{\max} = 160 \text{ bar}$ Super: $p_{\max} = 200 \text{ bar}$
Max. volume flow	$Q_{\max} = 100 \text{ l/min}$
Leakage volume flow	see characteristics

**ELECTRICAL SPECIFICATIONS**

Construction Solenoid, wet pin push type, pressure tight  
 Standard-Nominal voltage  $U_N = 12$  VDC  
 $U_N = 24$  VDC  
 $U_N = 110$  VAC\*  
 $U_N = 115$  VAC\*  
 $U_N = 230$  VAC\*  
 AC = 50 to 60 Hz  
 \*Rectifier integrated in the plug, other nominal voltages and nominal performances on request  
 Voltage tolerance  $\pm 10\%$  of nominal voltage  
 Protection class IP 65 to EN 60529  
 Relative duty factor 100% DF (see data sheet 1.1-430)  
 Switching cycles 15 000/h  
 Operating life  $10^7$  (number of switching cycles, theoretically)  
 Connection/Power supply Over device plug connection to ISO 4400/DIN 43650, (2P+E), other connections on request

**SOLENOID DESCRIPTION**

With respect to the selection of the solenoid, the following statements are important:

- The solenoid is the most expensive component of the solenoid spool valve.
- For this reason, it is not economical to use the same solenoid for all applications.
- Depending on the application, sales area, and customer, the requirements for solenoid spool valves and solenoids differ very considerably.
- In order to be able to offer the customer an optimum, we can supply our solenoid spool valves NG10 in 2 different versions  
 Solenoid: - Medium SIN60V (data sheet 1.1-145)  
 - Super SIS60V (data sheet 1.1-150)

**TYPE LIST / DESIGNATION OF SYMBOLS**

4/2-way valve impulse

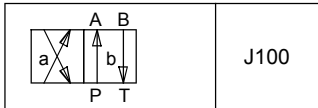

4/2-way valve with spring reset operation A-side

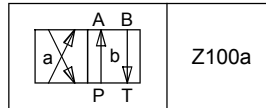

operation B-side

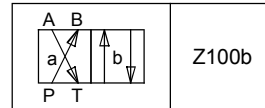

Transitional functions

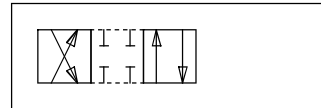

4/3-way valve spring centered

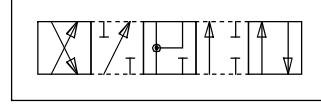
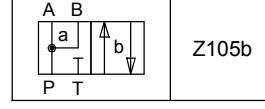
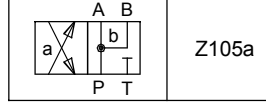
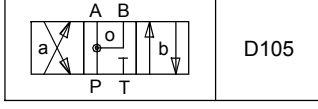
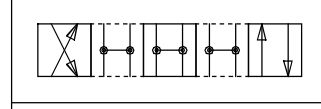
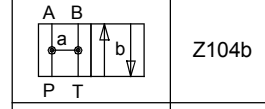
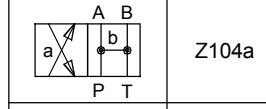
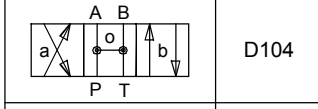
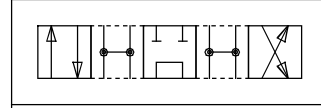
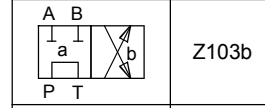
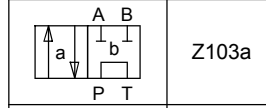
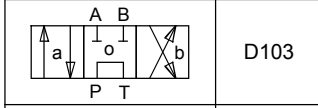
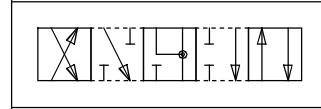
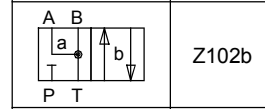
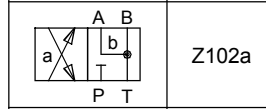
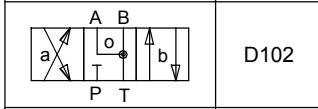
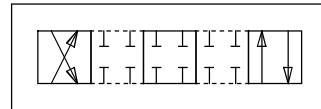
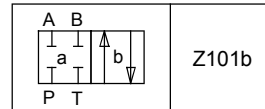
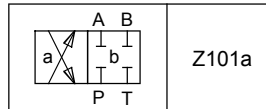
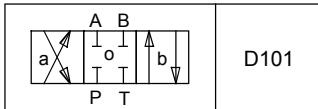

**CHARACTERISTICS** Oilviscosity  $\nu = 30$  mm<sup>2</sup>/s

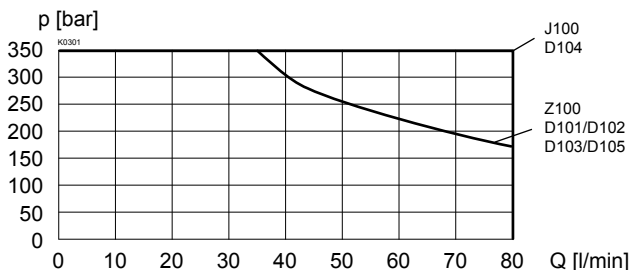
$p = f(Q)$  Performance limits with standard voltage -10% Medium

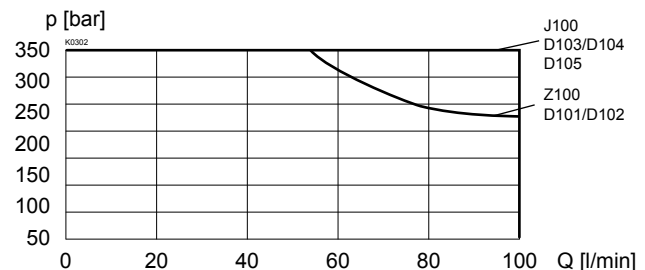

$p = f(Q)$  Performance limits with standard voltage -10% Super

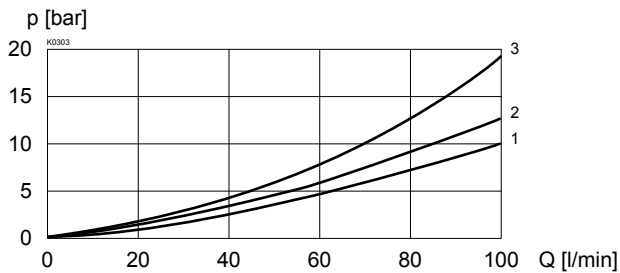

$\Delta p = f(Q)$  Pressure drop volume flow characteristics

Symbol	Pressure drop Curve no.	Volume flow direction				
		P - A	P - B	P - T	A - T	B - T
Z100/J100		2	2	-	2	2
D101/Z101		2	2	-	2	2
D102/Z102		2	2	-	1	1
D103/Z103		2	2	3	2	2
D104/Z104		1	1	-	1	1
D105/Z105		1	1	-	2	2

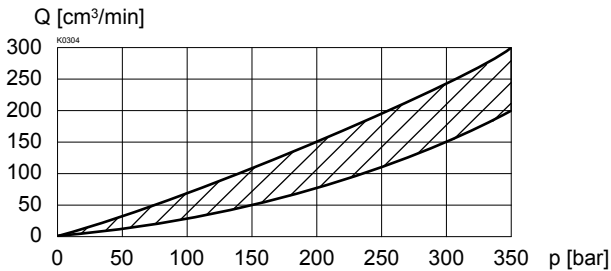
 $Q_L = f(p)$  Leakage volume flow characteristics per control edge

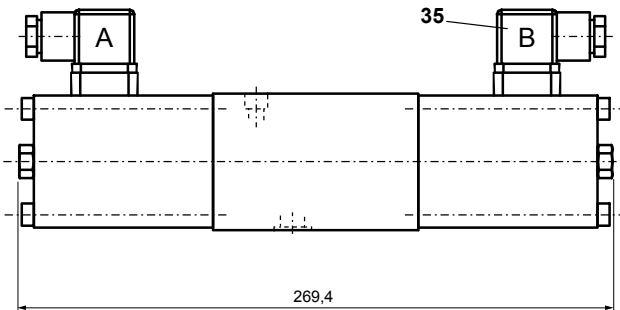
**DIMENSIONS**

 4/3-way valve (spring centred)  
 4/2-way valve (impulse)

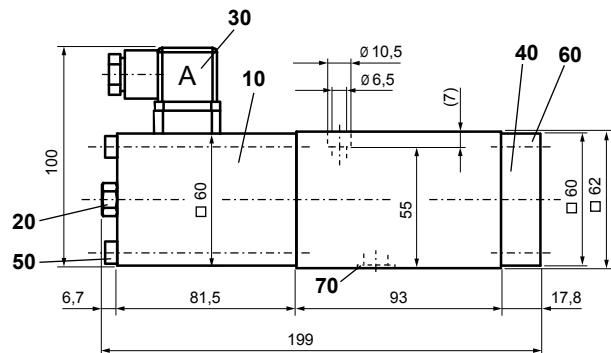
4/2-way valve (spring reset)

**PARTS LIST**

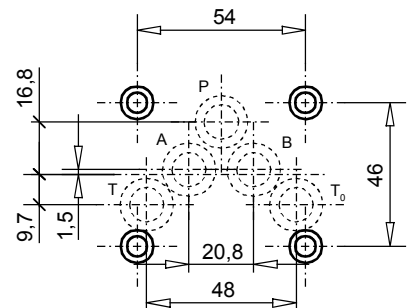
Position	Article	Description
10	260.8... 260.9...	Medium-solenoid SIN60V Super-solenoid SIS60V
20	253.8002	Plug with integrated manual override HB8,5
30	219.2001	Electric plug A (grey)
35	219.2002	Electric plug B (black)
40	059.2201 059.2203	Cover Medium Cover Super
50	246.3190	Socket head screw M6x90 DIN 912
60	246.3121	Socket head screw M6x20 DIN 912
70	160.2140	O-ring ID 14,00x1,78

**ACCESSORIES**

 Threaded connecting plates, Multi-flange subplates and  
 Longitudinal stacking system

see Reg. 2.9

Technical explanation see data sheet 1.0-100