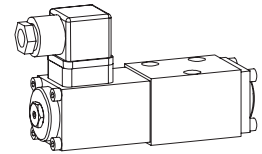

**Solenoid operated spool valve**

- 4/2-way impulse valve
- 4/3-way with spring centred mid position
- 4/2-way with spring reset
- $Q_{max} = 20 \text{ l/min}$ ,  $p_{max} = 350 \text{ bar}$

**NG4-Mini<sup>®</sup>**

**DESCRIPTION**

Direct operated solenoid valve with 4 ports in 5 chamber design. Spool detented or with spring reset. Precise spool fit, low leakage, long life time. Threaded ports through additional base plate. Spool made from hardened steel, body from high quality cast steel. Wide range of standard and special voltages.

The body made of high grade hydraulic casting for long service life is painted. The solenoid and the cover are zinc coated. The socket head screws are zinc coated.

**FUNCTION**

- 4/2-way detented spool valve:  
2 solenoids and 2 detented positions. With the solenoids deenergised the spool remains in the last switched position.
- 4/2-way spool valve:  
1 solenoid and 2 spool positions, spring offset. With the solenoid deenergised the spool returns to the offset position.
- 4/3-way spool valve:  
2 solenoids and 3 spool positions, spring centered. With the solenoids deenergised the spool returns to the center position.

**APPLICATION**

Solenoid operated spool valves are mainly used for controlling direction of movement and stopping of hydraulic cylinders and motors. Direction of movement depends on the position of spool and its flow symbol. Please pay attention to the performance limits and leakage of the valves. Solenoid operated spool valves are suitable for machine tools and handling systems. Miniature vales are used where both, reduced dimensions and weight are important.

**TYPE CODE**

Interface acc. to Wandfluh standard	B	<input type="checkbox"/>	4	<input type="checkbox"/>	-	<input type="checkbox"/>	#	<input type="checkbox"/>
Economy-solenoid	<input type="checkbox"/>	E						
Medium-solenoid	<input type="checkbox"/>	M						
Number of control ports								
Description of symbols acc. to table								
Nominal voltage $U_N$	12 VDC	<input type="checkbox"/>	G12					
	24 VDC	<input type="checkbox"/>	G24					
	110 VAC	<input type="checkbox"/>	R110					
	115 VAC	<input type="checkbox"/>	R115					
	230 VAC	<input type="checkbox"/>	R230					
Design-Index (Subject to change)								

**GENERAL SPECIFICATIONS**

Description	4/2-, 4/3-spool valve
Nominal size	NG4-Mini to Wandfluh standard
Construction	Direct operated spool valve
Operation	Solenoid
Mounting	Flange 3 fixing holes for socket head screws M5x40
Connections	Threaded connection plates Multi-flange subplates Longitudinal stacking system
Ambient temperature	-20...+50°C
Mounting position	any, preferably horizontal
Fastening torque	$M_D = 5,5 \text{ Nm}$ (screw quality 8.8)

Weight	Economy	Medium
4/2-way impulse	m = 1,2 kg	m = 1,4 kg
4/3-way	m = 1,2 kg	m = 1,4 kg
4/2-way (1 solenoid)	m = 0,83 kg	m = 0,93 kg

**HYDRAULIC SPECIFICATIONS**

Fluid	Mineral oil, other fluid on request
Contamination efficiency	ISO 4406:1999, classe 20/18/14 (Required filtration grade $\beta_{10...16} \geq 75$ ) refer to data sheet 1.0-50/2
Viscosity range	12 mm <sup>2</sup> /s...320 mm <sup>2</sup> /s
Fluid temperature	-20...+70°C
Working pressure in port P, A, B	Economy: $p_{Tmax} = 250 \text{ bar}$ Medium: $p_{Tmax} = 350 \text{ bar}$ ( $p_T < 20 \text{ bar}$ ) $p_{Tmax} = 315 \text{ bar}$ ( $p_T > 20 \text{ bar}$ )
Tank pressure in port T	$p_{Tmax} = 100 \text{ bar}$
Max. volume flow	$Q_{max} = 20 \text{ l/min}$ , see characteristics
Leakage volume flow	see characteristics

**ELECTRICAL CONTROL**

Construction Solenoid, wet pin push type, pressure tight

Standard-nominal voltage  $U_N = 12$  VDC  
 $U_N = 24$  VDC  
 $U_N = 110$  VAC\*  
 $U_N = 115$  VAC\*  
 $U_N = 230$  VAC\*  
 AC = 50 to 60 Hz

\* Rectifier integrated in the plug, other nominal voltages and nominal performances on request

Voltage tolerance  $\pm 10\%$  of nominal voltage

Protection class IP 65 to EN 60 529

Relative duty factor 100% DF (see data sheet 1.1-430)

Switching cycles 15'000/h

Operating life  $10^7$  (number of switching cycles, theoretically)

Connection/Power supply Over device plug connection to EN175301-803 (DIN43650) ISO 4400, form A, (2P+E), other connections on request.

**SOLENOID DESCRIPTION**

With respect to the selection of the solenoid, the following statements are important:

- The solenoid is the most expensive component of the solenoid spool valve.
- For this reason, it is not economical to use the same solenoid for all applications.
- Depending on the application, sales area, and customer, the requirements for solenoid spool valves and solenoids differ very considerably.
- In order to be able to offer the customer an optimum, we can supply our solenoid spool valves NG4 in 2 different versions:
  - Economy BEIIV (data sheet 1.1-100)
  - Medium SIN35V (data sheet 1.1-105)

**TYPE LIST / DESIGNATION OF SYMBOLS**

4/2-way valve impulse

4/2-way valve with spring reset operation A-side

operation B-side

Transitional functions

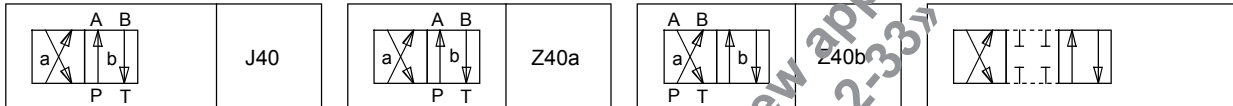

4/3-way valve spring centered

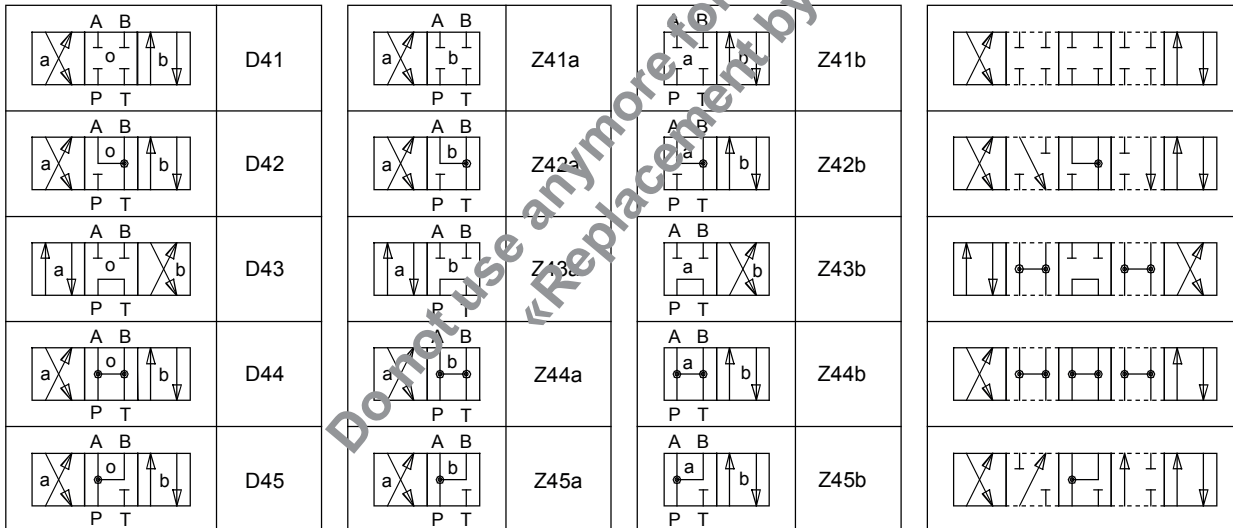
**CHARACTERISTICS** Oilviscosity  $\nu = 30$  mm<sup>2</sup>/s

$p = f(Q)$  Performance limits with standard voltage -10% Economy

$p = f(Q)$  Performance limits with standard voltage -10% Medium

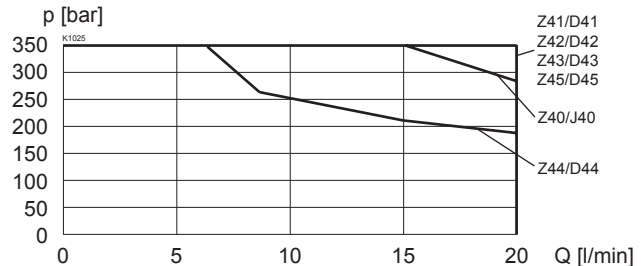
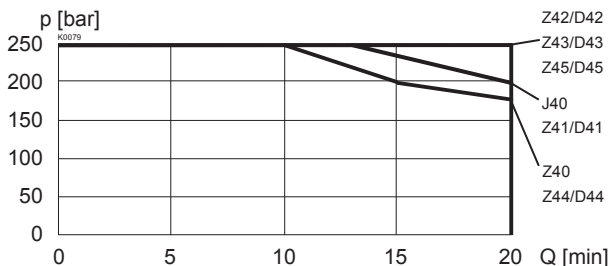

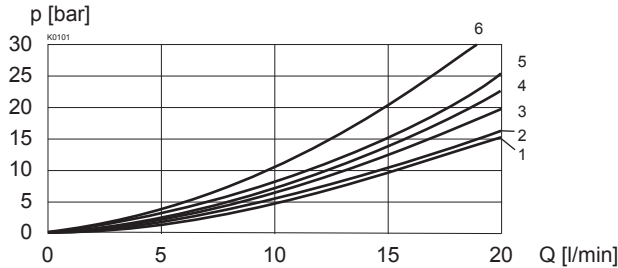
$\Delta p = f(Q)$  Pressure drop volume flow characteristics

Symbol	Pressure drop Curve no.	Volume flow direction				
		P - A	P - B	P - T	A - T	B - T
Z40/J40	5	5	5	-	2	2
D41/Z41	5	5	5	-	2	2
D42/Z42	5	5	5	-	1	1
D43/Z43	4	4	4	6	2	2
D44/Z44	4	4	4	3	2	2
D45/Z45	4	4	4	-	2	2

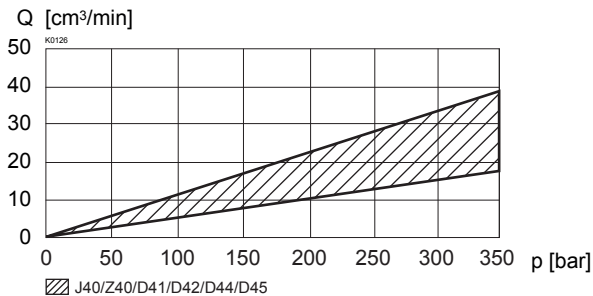
 $Q_L = f(p)$  Leakage volume flow characteristics per control edge

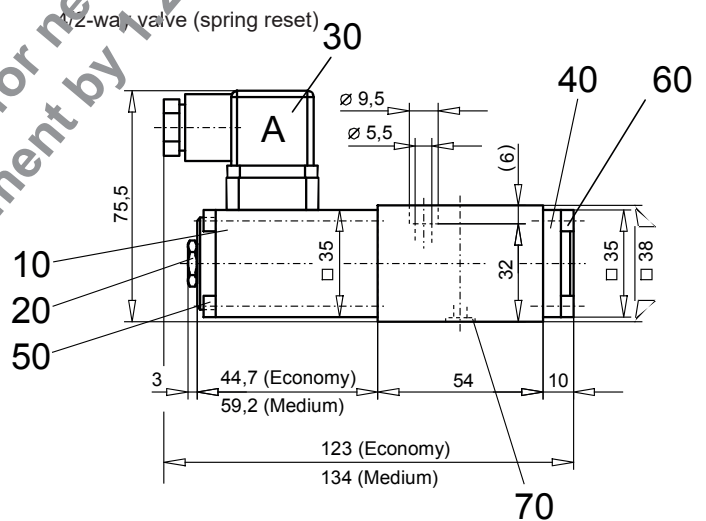
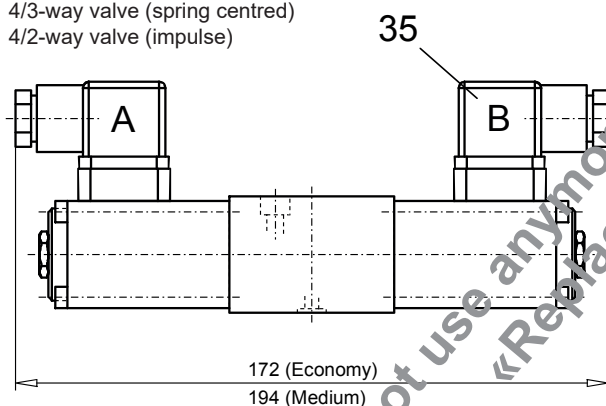
**DIMENSIONS**

 4/3-way valve (spring centred)  
 4/2-way valve (impulse)

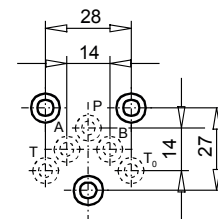
**PARTS LIST**

Position	Article	Description
10	260.1... 260.4...	Economy-solenoid BEIIV Medium-solenoid SIN35V
20	253.8000	Plug with integrated manual override HB4,5
30	219.2001	Electric plug A (grey)
35	219.2002	Electric plug B (black)
40	057.4202	Cover
50	246.1146 246.1161	Socket head screw M4x45 (BEIIV) Socket head screw M4x60 (SIN35V)
60	246.1113	Socket head screw M4x12 DIN912
70	160.2052	O-ring ID 5,28x1,78

**ACCESSORIES**

Threaded connecting plates, Multi-flange subplates and Longitudinal stacking system see Reg. 2.9

Technical explanation see data sheet 1.0-100