

Solenoid operated poppet valve

Sandwich construction

- ◆ 2/2-way
- ◆ normally open and normally closed
- ◆ $Q_{max} = 15 \text{ l/min}$
- ◆ $p_{max} = 350 \text{ bar}$

DESCRIPTION

Direct operated 2/2-way solenoid poppet valve in sandwich construction. By means of the pressure tight switching solenoid, the poppet valve spool is opened or closed acting against the spring. Due to the poppet spool construction with pressure compensation on both sides, the flow through the valve is possible in both directions. The seat spool guide is sealed by means of an O-ring. The metallic sealing seat closes the valve virtually leak free.

SYMBOL

Z.22041A

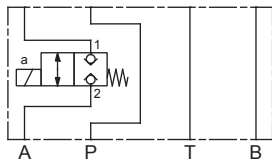

Z.22041B

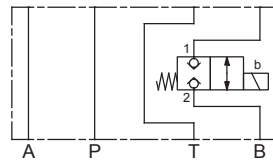

Z.22041P

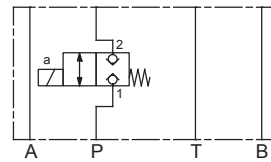

Z.22041T

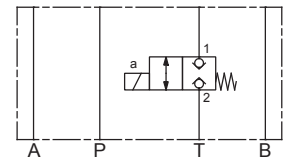

Z.22040A

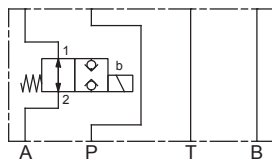

Z.22040B

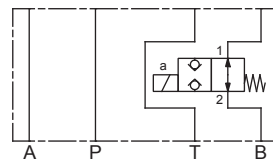

Z.22041AB

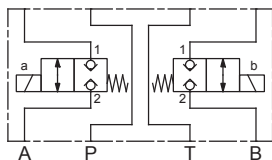

APPLICATION

Poppet valves are used where tight closing functions of the valve are essential like leakage-free load holding, clamping or gripping. Miniature valves are used where both, reduced dimensions and weight are important.

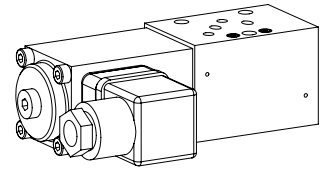

NG4-Mini Wandfluh standard

GENERAL SPECIFICATIONS

Designation	2/2-way poppet valve
Construction	Direct operated
Mounting	Sandwich construction
Nominal size	NG4-Mini according to Wandfluh standard
Actuation	Switching solenoid
Ambient temperature	-25...+70 °C (NBR) -20...+70 °C (FKM)
Weight	1,00 - 1,15 kg (1 solenoid) 1,75 kg (2 solenoids)
MTTFd	150 years

ACTUATION

Actuation	Switching solenoid, wet pin push type, pressure tight
Execution	Medium: SIN35V (Data sheet 1.1-105) Super: SIS35V (Data sheet 1.1-110)
Connection	Connector socket EN 175301 – 803

TYPE CODE

Poppet valve, sandwich construction		Z	<input type="checkbox"/>	2	<input type="checkbox"/>	2	<input type="checkbox"/>	04	<input type="checkbox"/>	-	<input type="checkbox"/>	-	<input type="checkbox"/>	#	<input type="checkbox"/>
Solenoid, Medium	<input type="checkbox"/>														
Solenoid, Super	<input type="checkbox"/>														
2 way (connections)															
2 switching positions															
Nominal size 4-Mini															
Normally closed	<input type="checkbox"/>														
Normally open	<input type="checkbox"/>														
Type list / Function															
Poppet valve	in P	<input type="checkbox"/>	in T	<input type="checkbox"/>											
	in A and B	<input type="checkbox"/>	in A	<input type="checkbox"/>	in B	<input type="checkbox"/>									
Nominal voltage U_N	12 VDC	<input type="checkbox"/>	115 VAC	<input type="checkbox"/>											
	24 VDC	<input type="checkbox"/>	230 VAC	<input type="checkbox"/>											
Sealing material	NBR	<input type="checkbox"/>													
	FKM (Viton)	<input type="checkbox"/>													
Design index (subject to change)															

1.11-2520

ELECTRICAL SPECIFICATIONS

Protection class	IP65
Relative duty factor	100 % DF
Switching frequency	15'000 / h
Service life time	10 ⁷ (number of switching cycles, theoretically)
Voltage tolerance	± 10 % with regard to nominal voltage
Standard nominal voltage	12 VDC, 24VDC, 115 VAC, 230 VAC AC = 50 to 60 Hz, rectifier integrated in the connector socket

Note! Other electrical specifications see data sheet 1.1-105 (Medium) and 1.1-110 (Super)

HYDRAULIC SPECIFICATIONS

Working pressure	Medium: $p_{max} = 160$ bar Super: $p_{max} = 350$ bar
Maximum volume flow	$Q_{max} = 15$ l/min, see characteristic
Volume flow direction	Any (see characteristic)
Leakage oil	Seat tight, max. 0,05 ml / min (approx. 1 drop / min) at 30 cSt
Fluid	Mineral oil, other fluid on request
Viscosity range	12 mm ² /s...320 mm ² /s
Temperature range fluid	-20...+70 °C
Contamination efficiency	Class 20 / 18 / 14
Filtration	Required filtration grade $\beta_{10...16} \geq 75$, see data sheet 1.0-50

PERFORMANCE SPECIFICATIONS

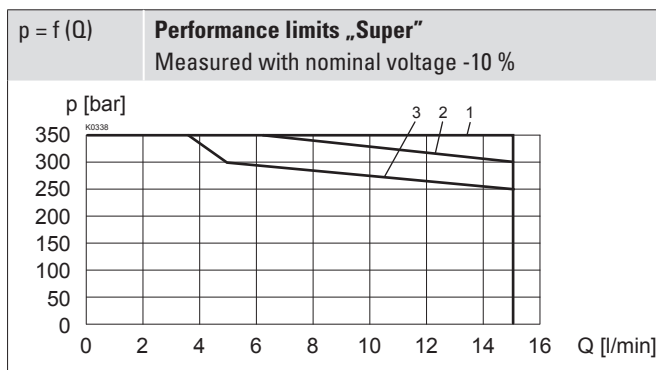
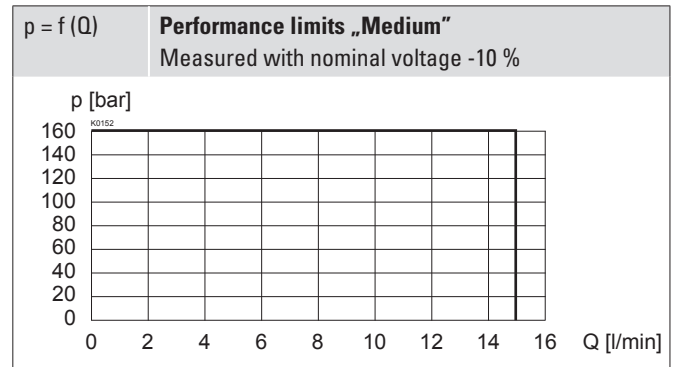
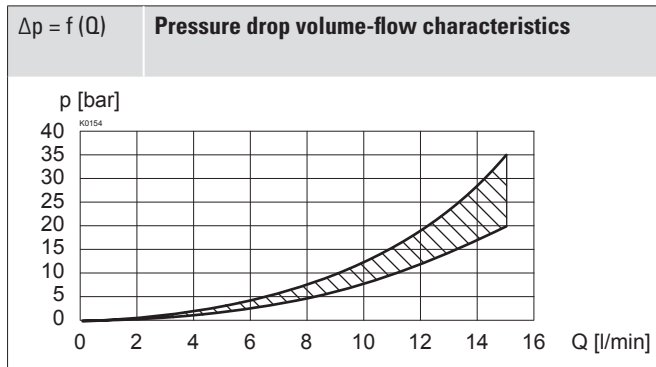
 Oil viscosity $\nu = 30 \text{ mm}^2/\text{s}$

Type	Flow direction	
	1 → 2	2 → 1
ZS22041.	1	3
ZS22040.	1	3

Attention! Long periods of non-actuation can reduce the switching performance

STANDARDS

Mounting interface	Wandfluh standard
Solenoids	DIN VDE 0580
Connection execution D	EN 175301 – 803
Protection class	EN 60 529
Contamination efficiency	ISO 4406

MANUAL OVERRIDE

Screw plug (HB0), no actuation possible

Optionally: HB4,5, HN(K) or HR(K)

→ See data sheet 1.1-311

COMMISSIONING

Attention! When commissioning, the valve must be vented under pressure (max. two rotations of screw E).

SURFACE TREATMENT

- ◆ The sandwich bodies made of steel are zinc-phosphated
- ◆ The solenoid and the cover are zinc coated
- ◆ The socket head screws are zinc coated

VALVES INSTALLED

The central functioning element is the poppet valve cartridge NG4, data sheet 1.11-2020.

ACCESSORIES

Fixing screws	Data sheet 1.0-60
Threaded subplates	Data sheet 2.9-05
Multi-station subplates	Data sheet 2.9-45
Horizontal mounting blocks	Data sheet 2.9-85
Technical explanations	Data sheet 1.0-100
Hydraulic fluids	Data sheet 1.0-50
Filtration	Data sheet 1.0-50
Relative duty factor	Data sheet 1.1-430

SEALING MATERIAL

NBR or FKM (Viton) as standard, choice in the type code

INSTALLATION NOTES

Mounting type	Sandwich mounting 3 fixing holes for socket head screws or studs M5
Mounting position	Any, preferably horizontal
Tightening torque	Fixing screws $M_D = 5,2 \text{ Nm}$ (screw quality 8.8, zinc coated)

DIMENSIONS

Poppet valves in A and B

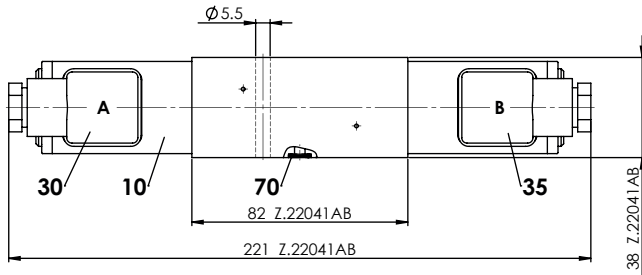

Poppet valve in B, P or T

E = Air bleed screw

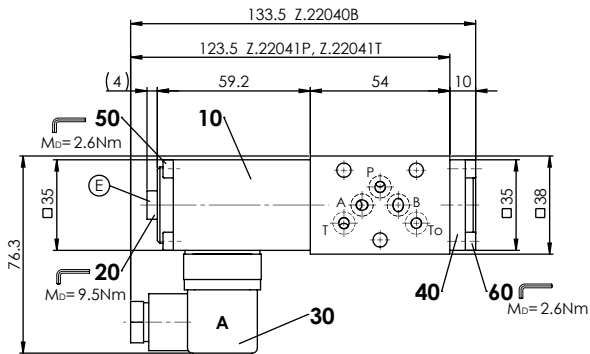

Poppet valve in A

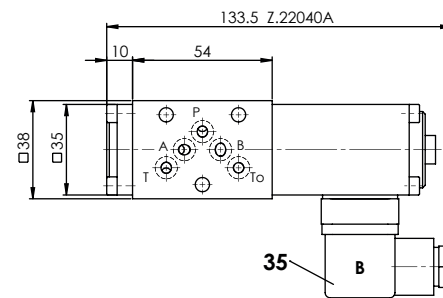

Poppet valve in A

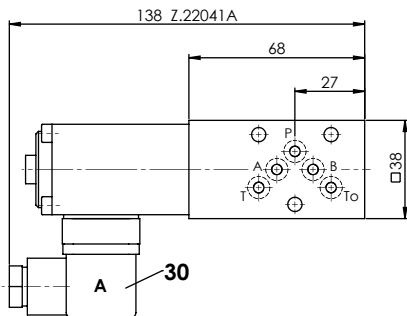

Poppet valve in B

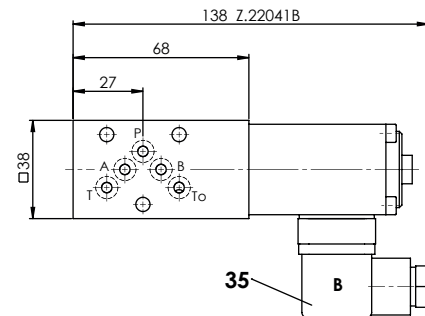

PARTS LIST

Position	Article	Description
10	260.4...	Solenoid SIN35V
	260.5...	Solenoid SIS35V
20	239.2033	Screw plug HB0 (incl. seal)
30	219.2001	Electric plug A (grey)
35	219.2002	Electric plug B (black)
40	057.4201	Cover
50	246.1161	Socket head screw M4 x 60 DIN 912
60	246.1113	Socket head screw M4 x 12 DIN 912
70	160.2052	O-ring ID 5,28 x 1,78 (NBR)
	160.6052	O-ring ID 5,28 x 1,78 (FKM)

HYDRAULIC CONNECTION

