

*Quality products for
demanding applications*



WANDFLUH ENERGY

“ We want to inspire our customers around the world with high-quality products and get engaged as a valuable partner in the development of technically demanding hydraulic systems. ”

————— Hansruedi Wandfluh and Matthias Wandfluh —————

WANDFLUH ENERGY

Redundancy and switching safety combined with a long service life are the main characteristics of components used in the energy sector. The hydraulic switching circuits at the heart of these installations often are a part of the system-relevant and sometimes safety-critical control elements in power plants.

FOCUS

In energy plants, extremely high forces are bundled and controlled. Since the advent of hydropower, hydraulic control systems have been used for this. They regulate water supply, for example, and control the angles of turbine blades. In the wind energy sector, the position of the rotor blades angles are adjusted hydraulically in a similar way as with water turbines. In addition, hydraulic brake systems are used in wind power plants to decelerate the turbines in case of heavy winds to prevent any damage to the installations. In thermal power plants, a typical application is controlling butterfly valves, which reduce the steam pressure quickly and in a controlled way in the event of an emergency. In all of these applications, safety is the top priority. Frequently redundant systems with switching position monitoring are used here which can be precisely adapted to the relevant system together with the customer.

...designed to ensure **extreme forces** and **a long service life**



ENERGY

APPLICATION EXAMPLES

- Steam flap controllers
- Adjustment of the rotor blades of wind generators
- Control of disc brakes
- Turbine controllers
- Process control
- Butterfly valve control
- Continuous positioning of solar panels

CHARACTERISTICS

- Corrosion protection valves, from zinc-nickel through to stainless steel
- Redundant systems
- Valve technology with switching position monitoring
- Precise adaptation to a hydraulics system by means of electronics developed in-house and intelligent software
- Parameterisable controller electronics with bus connection (HART, Profibus, etc.)
- Sensitive control characteristics
- Precise proportional valves
- Reduced electrical power
- Ease of maintenance
- BlueCompetence products
- Individual customer-specific adaptations
- Worldwide customer service



CONTROLLING ACTUATORS

Large process valves are often equipped with hydraulic actuations, since the high power density of the hydraulics enables a compact solution. Depending on the field of application, different requirements are placed on the hydraulic valves. This ranges from standard valves to valves with low leakage, explosion protected executions through to corrosion and acid-resistant components.

FUNCTION

On large process valves, a hydraulic actuator is mounted which is generally a hydraulic cylinder. By means of Wandfluh valves, a precise and secure controlling of the hydraulic cylinder is ensured. Since often only very small oil volumes are employed, compact and low-leakage control valves are of great importance. For the different actuators, a wide product range of spool valves and poppet valves is available.

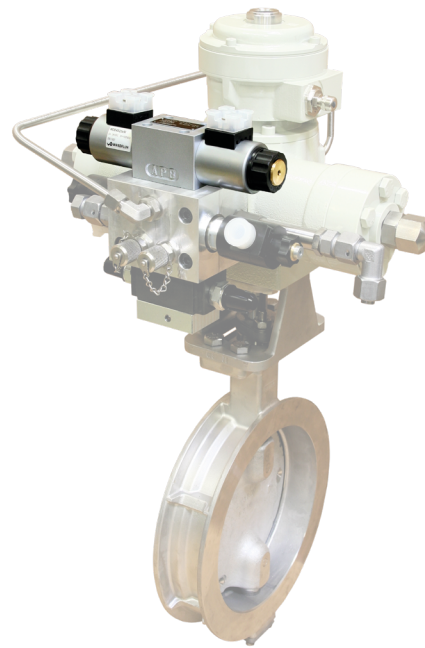
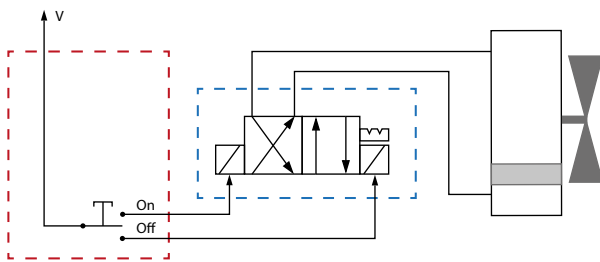

CONTROL

The actuators are mainly operated with on/off spool valves that have reduced leakage. Since in an installation many valves are controlled by means of a unit in the accumulator unloading operation, the leakage accumulates. For this reason, the smallest leakages possible are very important, but without impairing the switching reliability in harsh environments. In oil and gas environments, the valves are equipped with explosion protected solenoids. This execution is often related with high demands concerning corrosion. It is covered with a zinc/nickel coating or with stainless materials (AISI316L).

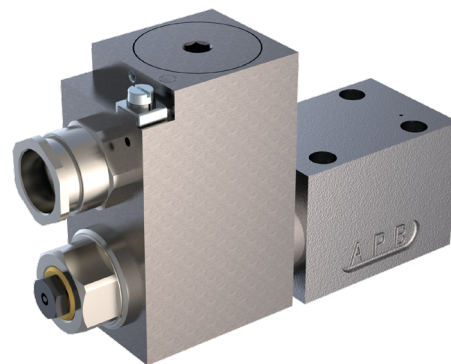

SPECIALITIES

- Low leakage spool valves, <math><15\text{ ccm/min}</math> at 150 bar
- Tight, compact poppet valves with direct cable outlet
- Ex d spool valves, Ex ia spool valves with reduced leakage
- Manual overrides in various executions, also stainless

REGULATING STEAM FLAPS

Steam flaps and butterfly valves are generally used in thermal power stations. So far, these were mostly coal, oil or nuclear power stations, although recently renewable energy sources are being increasingly important for steam production. The butterfly valves used serve as safety valves for the controlled release of overpressures in the system and are continuously electronically monitored by the existing safety systems.

FUNCTION

In safety valves, butterfly valves have the safety function of guaranteeing that no inadmissible pressures prevail in the main system. Wandfluh valves and electronic control cards ensure that the butterfly valve operates in conformity with safety standards. For varying opening and closing times, a wide product range of proportional spool valves and electronic control cards is available.

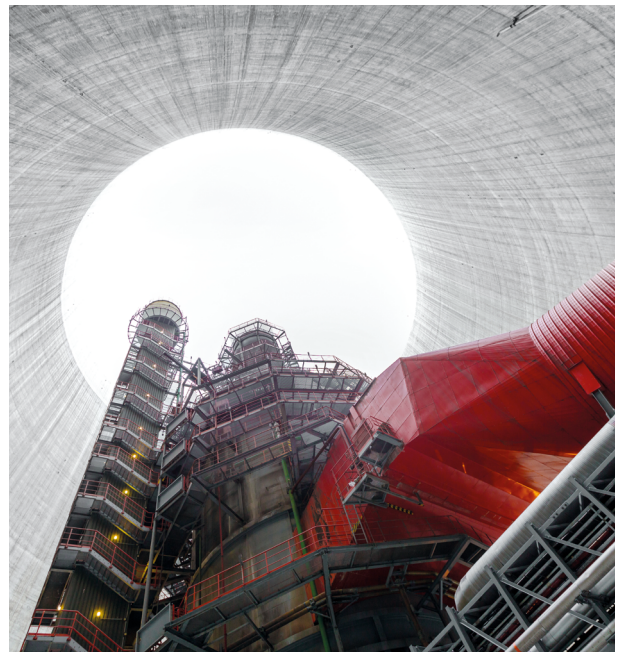
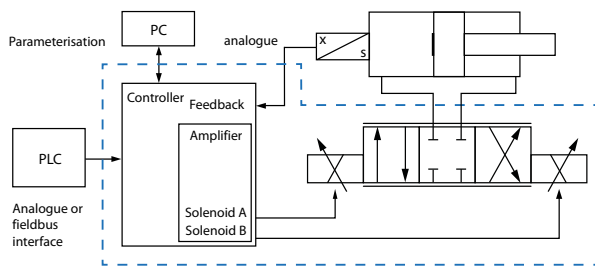

CONTROL

Butterfly valves are actuated in a closed control loop with proportional spool valves that have an optimised flow capacity. As a result of the safety requirement, the valves are controlled by means of control electronics that ensure the tight pressure, the boosting of emergency closing and the failure function.



SPECIALITIES

- Proportional valves with optimised flow capacity
- Control electronics with adapted software
- Valves available in various executions, including stainless steel

HYDROPOWER APPLICATION

The generation of hydroelectric power involves large quantities of water under high pressure driving several water turbines and the associated generators. The job of regulating and controlling these extremely high forces is done by the hydraulics.

To guarantee a shutdown in emergency situations too, hydraulic valves amongst other things have been developed that are controlled by the applied water pressure.

HYDRAULIC TURBINE CONTROLLER

Hydraulic Francis turbine controller for continuous operation, 24 h / 365 days a year. Redundant pump circuits make it possible to exchange pump units as well as filter elements during running operation. The hydraulic control is mounted on a 600 l tank and a stainless collecting tray. For emergency shutdown, rapid NG25 DIN cartridges are integrated. In order to position the turbine guide blades, a dynamic NG10 proportional spool valve is used. The innovative and energy-efficient concept with regulating pumps and accumulator elements is combined with a very compact construction.

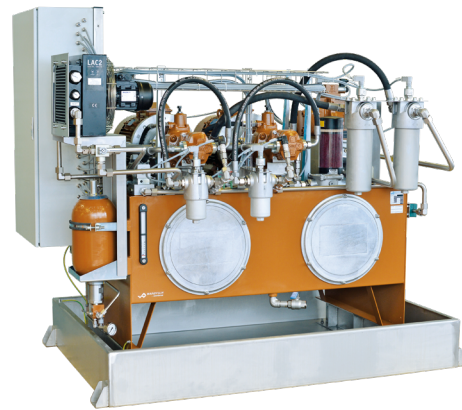

HYDRAULIC POWER UNIT FOR WATER CATCHMENT

The hydraulic power unit for a water catchment controls inlet and outlet gates, de-sander and other shut-off devices of the water catchment in a power station. Given the harsh environmental conditions at altitudes of more than 2,000 m, all pipes and sheet metal parts are made of stainless steel. With their special surface coatings, all hydraulic valves meet higher corrosion protection requirements. All valves actuated by solenoids are additionally equipped with star handle manual overrides. The modular valve arrangement ensures that also the manual operation of the unit is very clear. A pressure accumulator provides the energy to ensure continuous water catchment operation also in the event of temporary power failures.

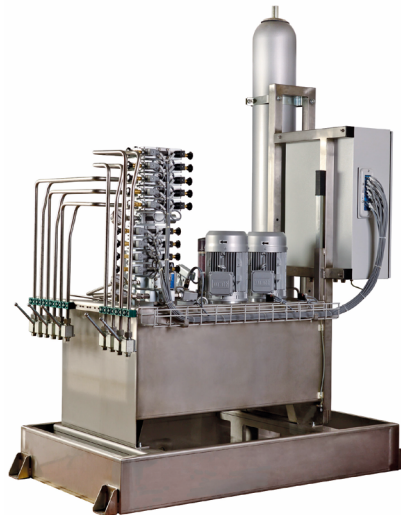

SPECIALITIES

- Designed for the highest availability and continuous use for at least 40 years
- Special surface coatings for increased corrosion protection
- All valve functions are equipped with easy-to-operate manual overrides
- Very compact construction
- Redundant components to increase availability and the possibility of exchanging during running operation
- Stainless steel actuators for the pilot control of the hydraulics with water
- Water-pressure controlled stainless steel actuators for the pilot control of the hydraulic system control of ball valves in hydroelectric power stations

WIND ENERGY APPLICATION

Wind power plants are designed to withstand the enormous forces of nature even in storms. However, this only functions due to a sophisticated self-protection, so that the rotor blades turn out the wind and the cell is held in a certain position. These enormous forces are controlled by hydraulic valves, which perform an important and safety-relevant function for the entire system.

BRAKE SYSTEMS

To control the forces caused by high wind speeds, the turbine brake systems are equipped with proportional pressure valves and tight poppet valves.

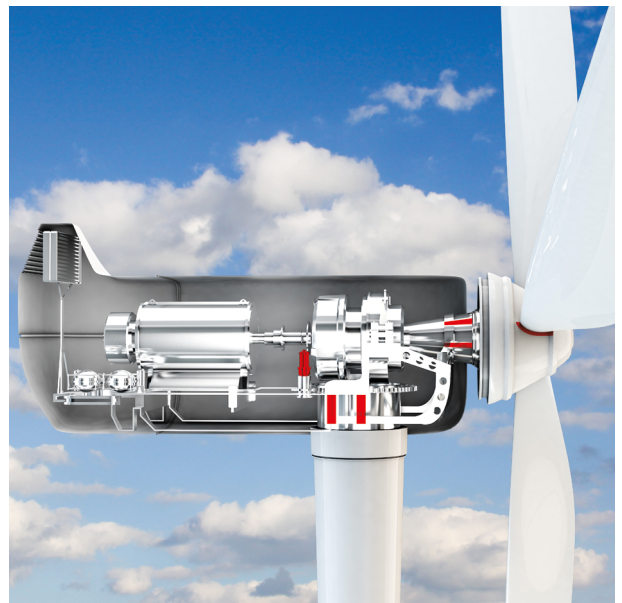
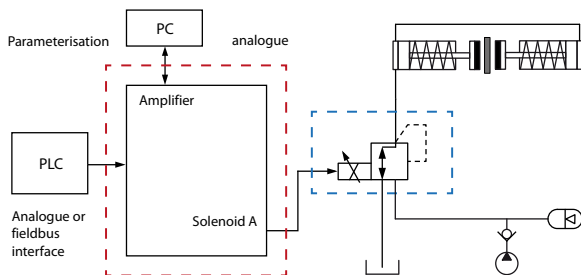

PITCH CONTROL (ROTOR BLADE ADJUSTMENT)

To ensure that as much wind energy as possible is converted into electrical energy, the rotor blades are optimally positioned in the wind. For this, a closed hydraulic control loop is necessary, which is achieved with precise proportional spool valves and the corresponding digital control electronics.

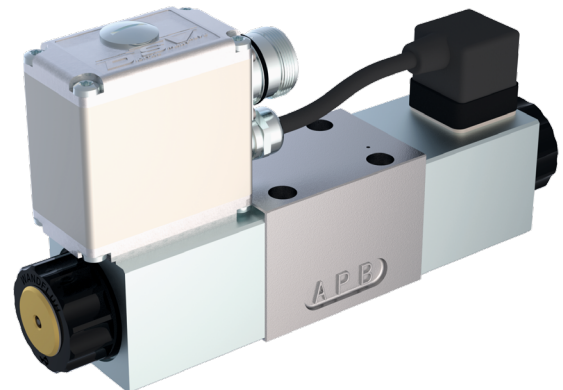

SPECIALITIES

- DSV valves with integrated electronics
- Valves with position monitoring
- Seat tight valves for the brake
- Enhanced corrosion protection

TYPICAL VALVES AND ELECTRONICS

Valves adapted to the various applications ensure that the different requirements such as small leakage, freely adjustable volume flows or pressures as well as seat tight closing of control lines can be readily realised. Perfect coordination of valve and electronics leads to simple drive solutions for precise movements and sensitive valve actuation.

SPOOL VALVES, FLANGE WDMF

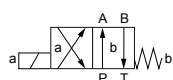
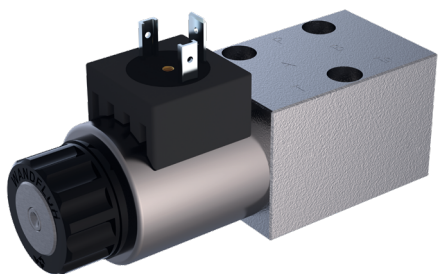

CHARACTERISTICS

Controls the oil flow and can thus, for example, determine the direction of movement of a cylinder. The valve is screwed as a flange onto a standardised mounting interface.

FEATURES

- Solenoid valve remotely controlled via intelligent electronics
- Direct or pilot operated
- Optionally detented, for safety in the case of power failure
- Small losses due to low leakage
- Soft switching for reduction of shocks
- Switching position monitoring
- Pressure max. 350 bar
- Flow max. 160 l/min
- Nominal sizes NG3, NG4, NG6, NG10

SPOOL VALVES WITH INTEGRATED ELECTRONICS WDRFA06

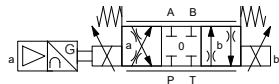
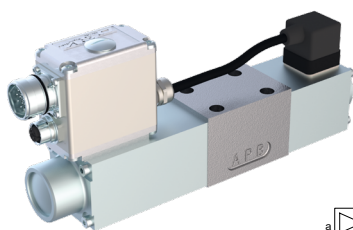

CHARACTERISTICS

The volume flow is controlled proportionally to the command value signal. The valve is factory set.

FEATURES

- Linear characteristics
- High dynamics (35Hz)
- Precise reproducibility and very small hysteresis
- Direct operated
- Integrated amplifier electronics with spool position control
- Optional with controller function
- Pressure max. 350 bar
- Flow max. 40 l/min
- Nominal sizes NG4, NG6

HART INTERFACE



CHARACTERISTICS

Simple communications interface for valves and actuators in the processing industry. Option for SD7.

FEATURES

- Protocol for bidirectional data transmission
- Signal transmission via 4-20 mA analog signal
- Parameterisation via HART
- Electronic Device Description (EDD) available

PRESSURE CONTROL VALVES MPPP

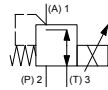

CHARACTERISTICS

The pressure at the output is continuously adjusted with the solenoid current and independently regulated by the valve.

FEATURES

- Linear characteristics and good repeatability
- Direct operated or pilot operated
- Smallest leakage for direct operated valves
- Pressure max. 350 bar
- Flow up to 200 l/min
- Nominal sizes M16, M18, M22, M33, M42 and U10

EXPLOSION PROTECTION POPPET VALVES SDYP

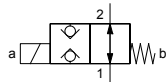
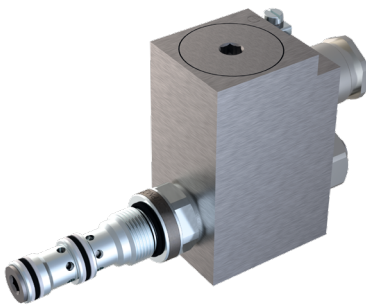

CHARACTERISTICS

For seat tight closing functions such as leak-free load holding, clamping and gripping or for pilot control of larger valves.

FEATURES

- Excellent durable tightness as a result of metallically sealing seat
- Direct and pilot operated
- Poppet spool construction with equal areas and pressure compensation on both sides
- Tight seal in all directions of flow
- 2/2- and 3/2-way execution
- Cartridge, flange and sandwich construction

MINIATURE AMPLIFIER PD2



FEATURES

Digital amplifier module for controlling a proportional valve. PD2 is an electronics unit with cable connection. In the MPS version, it is mounted fixed on a solenoid.

CHARACTERISTICS

- IP67 housing
- Solenoid current regulated
- Command value as voltage or current
- Digital input
- Parameterisable by means of PASO software or display and buttons on the device
- Optional with fieldbus (CANopen or J1939)
- Housing with cable connections or mounted on the solenoid

ELECTRONICS SD7



CHARACTERISTICS

Digital controller module for regulating position, pressure or volume flow including integrated amplifier.

FEATURES

- Controller mode selectable: pressure, position, speed
- Solenoid current regulated, with superimposed dither
- Command and feedback values as voltage or current
- Up to 7 digital inputs and up to 4 outputs
- Optionally with fieldbus (CANopen, Profibus DP, HART)
- Housing for dome rail mounting
- SSI interface
- Analog output

EXPLOSION PROTECTION CORROSION PROTECTION

Flammable gases, vapours and dust can form an explosive atmosphere when mixed with oxygen. In order to ensure a high level of safety, appropriate protective regulations exist for the various operating equipment to avoid the risk of explosion hazards. The solenoid as an electrical actuation in the valve technology must therefore demonstrate a type of protection that is in line with the explosion protection standard.

Valves that are exposed to continuous contact with salty water and atmospheres that contain salt or to harsh weather conditions demand enhanced corrosion protection in order to prolong their service life.

EXPLOSION PROTECTION

Description

- Electrical operating equipment for all explosion hazard zones
- Solutions for valves and systems
- Optionally enhanced corrosion protection up to stainless steel executions

Functions

- Solenoid spool valves
- Solenoid poppet valves
- Proportional spool valves
- Proportional pressure valves (relief and reducing)
- Proportional flow valves (throttle and flow control)
- Electronics integrated into the valve for proportional functions

Features

- Type of protection flameproof enclosure (Ex d) for zone 1 and 2
- Type of protection intrinsic safety (Ex i) for zone 0
- Certified solenoids for surface and mining areas
- Certificates for ATEX, IECEx, EAC, UL/CSA, Australia, MA

CORROSION PROTECTION

K8: 500 - 1000 h salt spray test

- Zinc-nickel coating, or made of stainless materials.

K9: > 1000 h salt spray test

- Mainly made of stainless and acid-resistant steel AISI 316L. The solenoids are zinc-nickel coated.

K10: > 1000 h salt spray test

- All elements made of stainless materials (AISI 316L) or coated with stainless materials.

LOW TEMPERATURES

Z604: -40° C

- Adapted sealing, adjustment tolerances partly adapted

Z591: -60° C

- Special materials, special sealings, adjustment tolerances enhanced

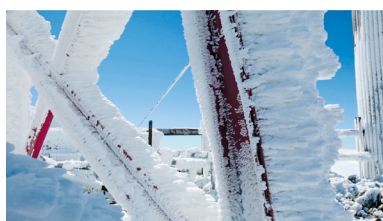

SPECIAL VALVES

Wandfluh valves are constructed in a modular way and are thus very flexible in their composition. This allows different standard functional elements to be combined, so that individual solutions can be easily realised.

POPPET VALVES WITH DETENT FUNCTION AEXD3206RR

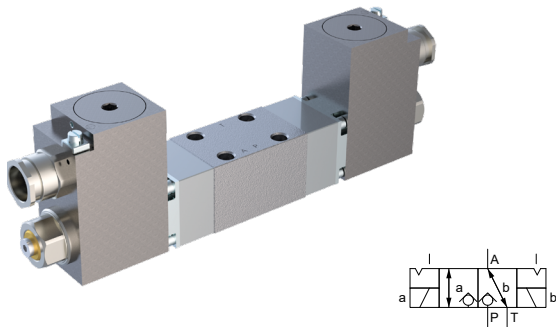

CHARACTERISTICS

The practically leakage-free poppet valve spool can be opened or closed against the applied spring pressure and mechanically detented in the desired position by an electrical impulse.

FEATURES

- 3-way function
- Electrical actuation with standard or Ex d solenoids
- Combination of an electrical actuation with a mechanical actuation possible
- Spool position monitored with position sensor
- Pressure max. 350 bar
- Flow max. 40 l/min

VALVES WITH SWITCHING POSITION MONITORING WDMFA_Z

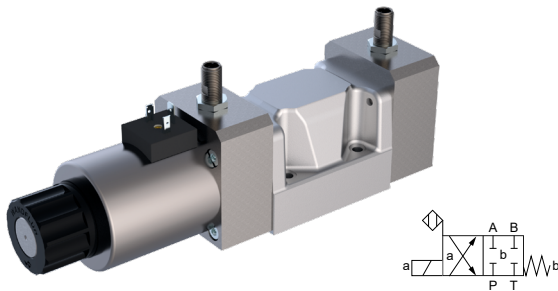

CHARACTERISTICS

Electronic sensors detect the switching position of the valve spool. The evaluation of the command/feedback signals considerably increases the safety of an installation.

FEATURES

- For various spool and poppet valves
- In combination with standard and Ex d solenoids
- Inductive switching sensor
- Pressure max. 350 bar
- Flow max. 160 l/min
- Nominal sizes NG6, NG10

SEAT TIGHT PRESSURE CONTROLLERS MSDPM22



CHARACTERISTICS

Controls the set output pressure independently of the volume flow and closes seat tight. This leads to a significant reduction of losses in a hydraulic system.

FEATURES

- Manual adjustment of the output pressure
- Good pressure control in case of volume flow fluctuations
- Seat tight
- Pressure max. 350 bar
- Flow max. 20 l/min
- Cartridge with cavity M22x1,5

SWITZERLAND

Wandfluh AG

Helkenstrasse 13
3714 Frutigen
Phone +41 33 672 72 72
sales@wandfluh.com

SWITZERLAND

Wandfluh Produktions AG

Parallelstrasse 42
3714 Frutigen
Phone +41 33 672 73 73
wapro@wandfluh.com

FRANCE

Wandfluh SARL

Parc Technologique
Immeuble le Pôle
333, Cours du Troisième Millénaire
69791 Saint-Priest Cedex
Phone +33 4 72 79 01 19
contact@wandfluh.fr

GERMANY

Wandfluh GmbH

Friedrich-Wöhler-Strasse 12
78576 Emmingen
Phone +49 74 65 92 74 0
info@wandfluh.de

GERMANY

Wandfluh SM GmbH

Silbersteinstrasse 3
97424 Schweinfurt
Phone +49 97 21 77 65 0
info-sm@wandfluh.de

CHINA

Wandfluh (Shanghai) Hydraulic System Co. Ltd.

No. 450 Beihengshahe Road
Minhang District
Shanghai 201 108
Phone +86 21 67 68 12 16
sales@wandfluh.com.cn

USA

Wandfluh of America, Inc.

8200 Arrowridge Boulevard, Suite-D
Charlotte, NC 28273
Tel. +1 847 566 57 00
sales@wandfluh-us.com

UNITED KINGDOM

Wandfluh UK Ltd.

Northfield Road
Southam CV47 0FG
Phone +44 1 926 81 00 81
sales@wandfluh.co.uk

AUSTRIA

Wandfluh GmbH

Färbergasse 15
6850 Dornbirn
Phone +43 55 72 38 62 72 0
office-at@wandfluh.com

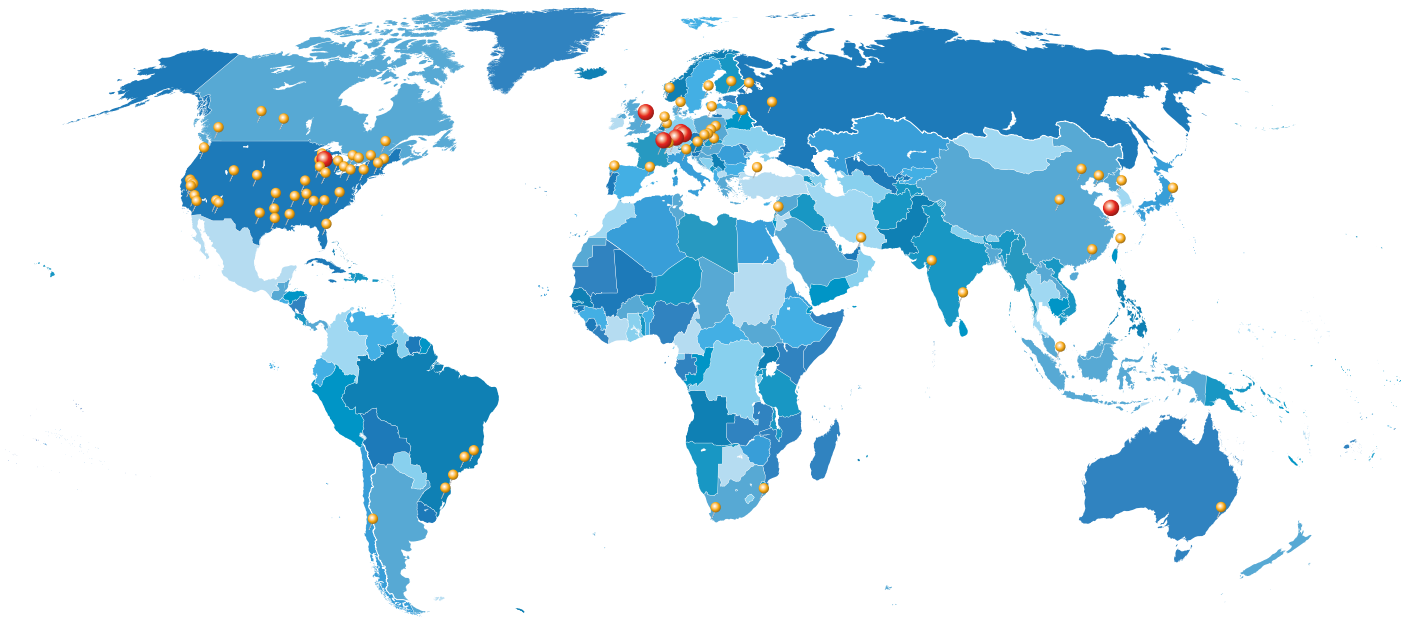

SOLUTIONS SINCE 1946